

# Probabilistic Parity Shaping for Linear Codes

**OWHTC 2019**

February 27-28, 2019

DLR Oberpfaffenhofen, Germany

Mathematical and Algorithmic Sciences Lab  
Paris Research Center  
Georg Böcherer

[www.huawei.com](http://www.huawei.com)

February 27, 2019

HUAWEI TECHNOLOGIES CO., LTD.



# Acknowledgment

- **Diego Lentner** (co-woker at Huawei Paris, future doctoral student at TUM).
- **Alessandro Cirino** (master student, intern at Huawei Paris)
- **Fabian Steiner** (doctoral student at TUM)
- Paper on <https://arxiv.org/abs/1902.10648>

**Probabilistic Parity Shaping for Linear Codes**  
Georg Böcherer, *Member, IEEE*, Diego Lentner, Alessandro Cirino, Fabian Steiner, *Student Member, IEEE*

[8] F. Buchali, G. Böcherer, W. Idler, L. Schmalen, P. Schulte, and F. Steiner, "Experimental demonstration of capacity increase and rate-adaptation for probabilistically shaped 64-QAM," in *Proc. Eur. Conf. Opt. Commun.*, Valencia, Spain, 2015, Paper PDP3.4.

[9] F. Buchali, F. Steiner, G. Böcherer, L. Schmalen, P. Schulte, and W. Idler, "Rate adaptation and reach increase by probabilistically shaped 64-QAM: An experimental demonstration," *J. Lightw. Technol.*, vol. 34, no. 7, pp. 1599–1609, Apr. 2016.

[10] F. Buchali, W. Idler, L. Schmalen, G. Böcherer, P. Schulte, and F. Steiner, "Probabilistically shaped QAM for independent reach, spectral efficiency and bit-rate adaptation," in *Proc. Eur. Conf. Opt. Commun.*, Düsseldorf, Germany, Sep. 2016, Paper W.1.C.

[11] J. Cho *et al.*, "Trans-Atlantic field trial using probabilistically shaped 64-QAM at high spectral efficiencies and single-carrier real-time 250-Gb/s transmission," in *Proc. Fiber Commun. Conf.*, 2017, Paper Th.5.B.3.

[12] J. Cho *et al.*, "Advanced C+L-band transoceanic transmission using probabilistically shaped PDM-64QAM," *J. Lightw. Technol.*, vol. 35, no. 8, pp. 1299–1309, Apr. 2017.

# Last 5 Years: Probabilistic Shaping Revival

[14] J. Li *et al.*, "Constellation shaping for 200-Gb/s coherent transmission," *Proc. Asia Commun. Photon. Conf.*, 2016, Paper M4E.3.

[15] M. P. Yankov *et al.*, "Constellation shaping for 256QAM/1024QAM with probabilistic shaping," *J. Lightw. Technol.*, vol. 34, no. 22, pp. 5146–5156, Nov. 2016.

[16] R. Maher, K. Croussore, M. Lauermann, R. Going, X. Chen, and F. Steiner, "Constellation shaped 66 GBd DP-1024QAM transceiver with transmission over standard SMF," in *Proc. Eur. Conf. Opt. Commun.*, 2017, Paper PDPB.2.

[17] Z. Qu, S. Zhang, and I. B. Djordjevic, "Universal hybrid probabilistic-geometric shaping based on two-dimensional distribution matchers," in *Proc. Opt. Fiber Commun. Conf.*, San Diego, CA, USA, Mar. 2018, Paper M4E.4.

[18] S. L. I. Olsson, J. Cho, S. Chandrasekhar, X. Chen, E. C. Burrows, and P. J. Winzer, "Record-high 17.3-bit/s/Hz spectral efficiency transmission over 50 km using probabilistically shaped PDM 4096-QAM," in *Proc. Opt. Fiber Commun. Conf.*, Mar. 2018, Paper Th.4.C.5.

[19] F. Steiner *et al.*, "Experimental verification of rate flexibility and probabilistic shaping by 4D signaling," in *Proc. Opt. Fiber Commun. Conf.*, Mar. 2018, Paper M.4.E.3.

[20] O. Geller, R. Dar, M. Feder, and M. Shttaif, "A shaping algorithm for mitigating inter-channel nonlinear phase-noise in nonlinear fiber systems," *J. Lightw. Technol.*, vol. 34, no. 16, pp. 3884–3889, Aug. 2016.

[21] M. P. Yankov, K. J. Larsen, and S. Forchhammer, "Temporal probabilistic shaping for mitigation of nonlinearities in optical fiber systems," *J. Lightw. Technol.*, vol. 35, no. 10, pp. 1803–1810, May 2017.

# Now Commercialized:



TOPICS / PARTNER PERSPECTIVES

## China Telecom & Huawei Jointly Completed the Industry's First PCS-based 200G/400G Ultra-Long-Haul Field Trial in a Commercial WDM Network



PARTNER  
PERSPECTIVES  
HUAWEI

11/21/2018

COMMENT (0)

China Telecom and Huawei recently completed the first 200G/400G ultra-long-haul field trial to be performed on a commercial WDM network, putting probabilistic constellation shaping (PCS) to good use and revealing nearly 1200 km of un-regenerated transmission on the live network. An academic paper entitled Field Trial of Probabilistic-Shaping-Programmable Real-Time 200-Gb/s Coherent Transceivers in an Intelligent Core Optical Network, which is based on a real-time field trial in a deploying national WDM network, was accepted as a post-deadline paper (PDP) and presented at the 18th Asia Communications and Photonics Conference (ACP) held in Hangzhou, China. The ACP is the most influential technical conference in optical communications and photonics in the Asia-Pacific region, and the PDP submissions showcase the significance of the latest research results. This paper was presented as the first PDP in the optical transmission and networking category.



## M-net trials 500-Gbps via Nokia super coherent Photonic Service Engine 3 with probabilistic constellation shaping

February 7, 2019

Author Stephen Hardy  
Editorial Director and Associate Publisher

M-net has conducted field trials of the super coherent capabilities of Nokia's Photonic Service Engine 3 (PSE-3) coherent ASIC, the two companies say. The trial saw the use of probabilistic constellation shaping to support wavelengths of 500 Gbps.



# Key to Success: Layered Architecture for Linear FEC Codes

- **2015: Probabilistic Amplitude Shaping [1]:**  
shaped amplitude bits (and un-shaped sign bits for parities)
- **1981: Reverse concatenation [2]:**  
constrained bits (and un-constrained bits for parities)

[1] G. Böcherer, F. Steiner, and P. Schulte, “Bandwidth efficient and rate-matched low-density parity-check coded modulation,” *IEEE Trans. Commun.*, vol. 63, no. 12, pp. 4651–4665, Dec. 2015.

[2] W. G. Bliss, “Circuitry for performing error correction calculations on baseband encoded data to eliminate error propagation,” *IBM Tech. Discl. Bull.*, vol. 23, pp. 4633–4634, Mar. 1981.

# What if there are no un-constrained bits?

- **Several interesting use cases:**
  - On-Off Keying (OOK) → **Balazs' talk on Thursday 5:30pm, [4]**
  - High FEC overhead
  - Multiuser system (e.g., dirty paper coding)
  - ...
- **We do not consider Polar coding (a very nice solution)**
  - **Thomas Wiegart's poster**

**[3]** A. Git, B. Matuz, and F. Steiner, "Protograph-Based LDPC Code Design for Probabilistic Shaping with On-Off Keying," in *Proc. Ann. Conf. Inf. Sci. Syst. (CISS)*, Mar. 2019.

# What if there are no un-constrained bits?

- **We are interested in a general architecture like PAS that integrates with (decoding of)**
  - LDPC codes
  - Turbo product-codes
  - Algebraic codes
  - ...

# Linear Layered Probabilistic Shaping: Outline

- **It's an encoding problem!**
- **Systematic encoding revisited:**
  - 2-step approach
  - PAS encoding
  - Shaped parity bits
- **Rate matching**
- **Application: dirty paper coding**
- **Conclusions**



## By all-zero codeword/ scrambling trick:

- Evaluate the decoder for shaped codewords
- Design codes for shaped codewords

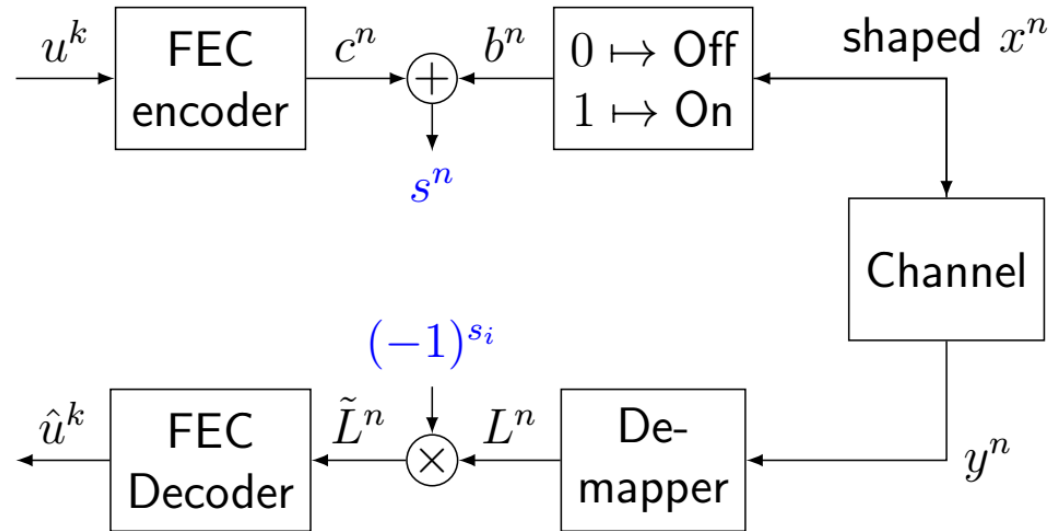

# It's an Encoding Problem!

## Questions:

- What is the overall rate?
- What FEC rate is achievable?

# It's an Encoding Problem!

By [4]:

- **Achievable FEC rate is**  $(1 - R_{\text{fec}}) < H(X|Y)$
- **Overall rate is**  $R = [H(X) - (1 - R_{\text{fec}})]^+$
- **Ideal code achieves**  $R^* = I(X; Y)$

[4] G. Böcherer, P. Schulte, and F. Steiner, “Probabilistic Shaping and Forward Error Correction for Fiber-Optic Communication Systems,” *J. Lightw. Technol.*, vol. 37, no. 2, pp. 230–244, Jan. 2019.

# Systematic Encoding in 2 steps

- **Parity check matrix**  $H = [H_s | H_p]$

where  $H_s$  is  $m \times k$  and  $H_p$  is  $m \times m$  and has full rank.

- **Systematic encoding:**

codeword  $[v|p]$  in two steps

- 1) Calculate the syndrome  $s = vH_s^T$ .
- 2) Calculate the parity bits  $p = s(H_p^T)^{-1}$ .

# PAS Encoding

- Parity check matrix  $H = [H_s | H_p]$

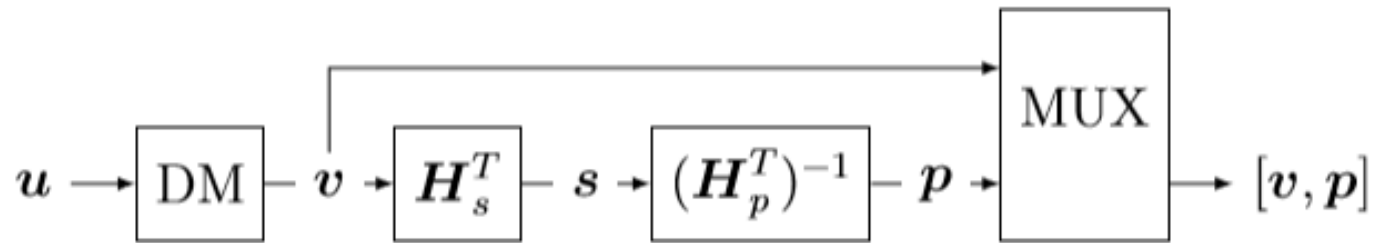

# LLPS Encoding

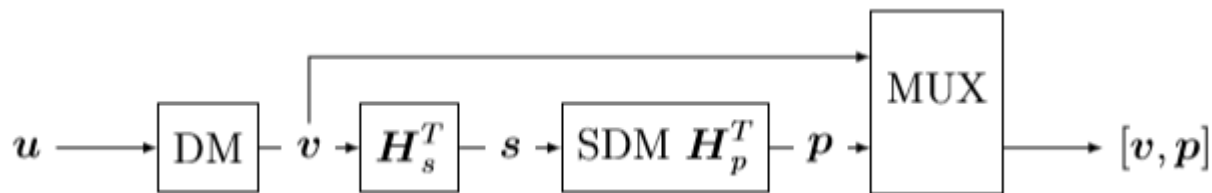
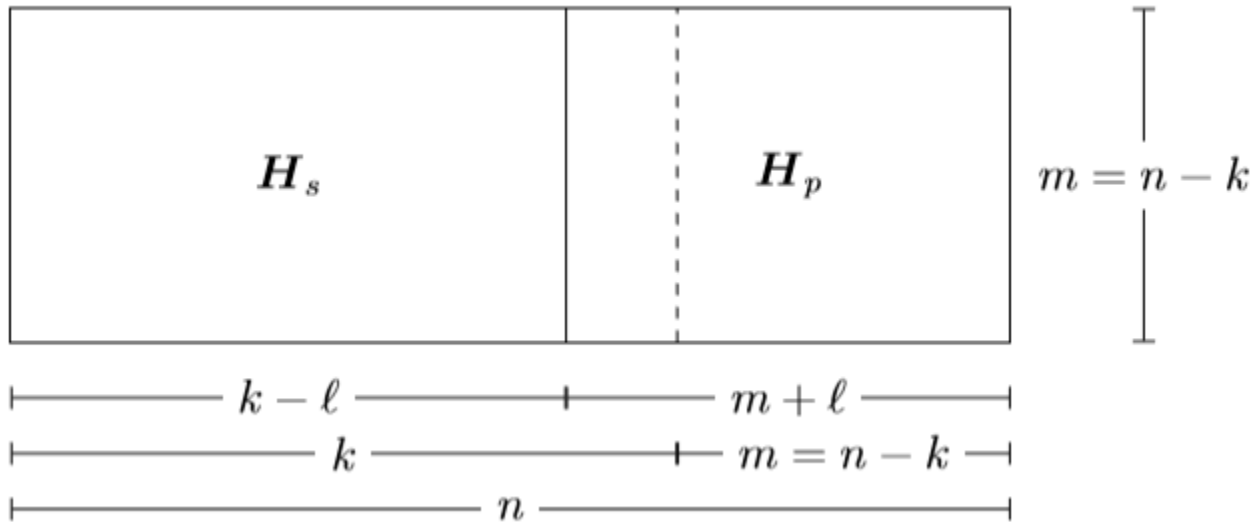

# Enabling Component: Syndrome Distribution Matcher (SDM)

- SDM has input  $s$  and output  $p = \underset{p' \in \{0,1\}^{m+\ell}}{\operatorname{argmin}} f(p')$   
subject to  $p' H_p^T = s$ .
- **Two immediate implementations:**
  - Calculate offline and store size  $2^m$  LUT (memory limited).
  - Calculate online size  $2^\ell$  coset (time limited).
- **Research efficient algorithms** for when neither  $m$  nor  $\ell$  are small.

# Rate Matching

- **Ideal components:**

$$m = n \mathbb{H}(B|Y)$$

$$k_{\text{info}} = \mathbb{H}(B)(k - \ell)$$

$$m = \mathbb{H}(B)(m + \ell).$$

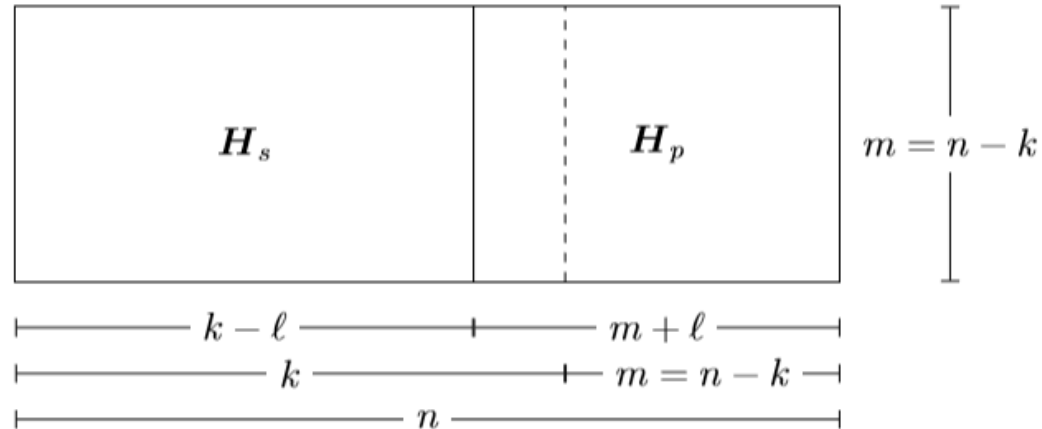

- **Rate** 
$$R = \frac{k_{\text{info}}}{n} = \mathbb{H}(B) \frac{k - \ell}{n}$$

$$= \mathbb{H}(B) \frac{k + m - m - \ell}{n}$$

$$= \mathbb{H}(B) - \frac{\mathbb{H}(B)(m + \ell)}{n}$$

$$= \mathbb{H}(B) - \frac{m}{n}$$

$$= \mathbb{H}(B) - \mathbb{H}(B|Y) = \mathbb{I}(B; Y).$$

→ Any rate  $0 \leq R \leq R_{\text{fec}}$   
Possible!!

# Dirty Paper Coding

- Channel

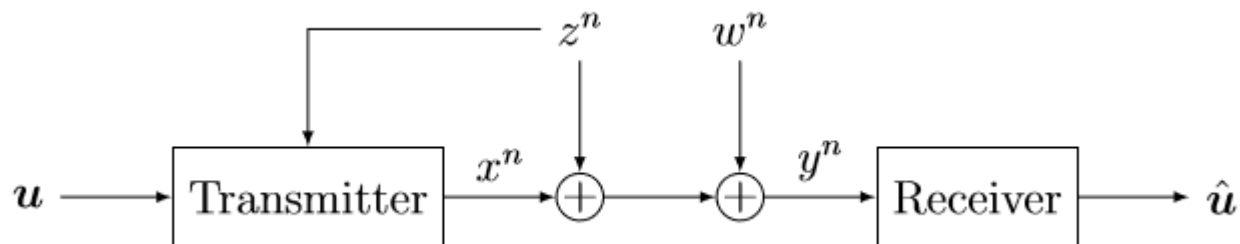

- LLPS-DPC Encoder

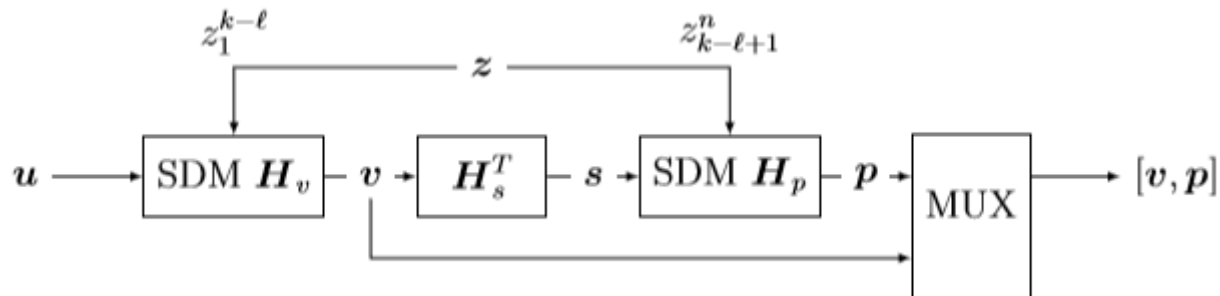



# Achievable Rate

- **$i$ th channel use:**  $Y_i = \alpha x_{b_i} + \beta Z_i + W_i$
- **Achievable rate by [4,6]:**  $R_{\text{dpc}} = \mathbb{I}(B; Y) - \mathbb{I}(B; Z), \quad BZ \sim P_Z P_{B|Z}$
- **Optimized distribution:**

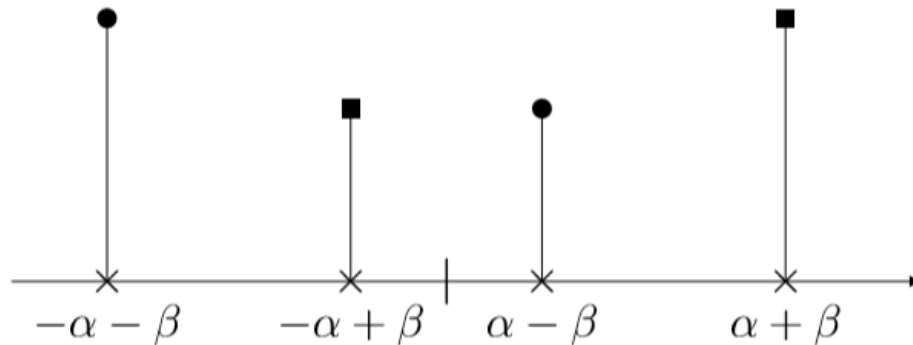

- [5] G. Kramer, "Topics in multi-user information theory," *Foundations and Trends in Comm. and Inf. Theory*, vol. 4, no. 4–5, pp. 265–444, 2007.
- [6] D. Lentner, "Dirty paper coding for higher-order modulation and finite constellation interference," Master's thesis, Technical University of Munich, 2018.

# Dirty Paper Coding

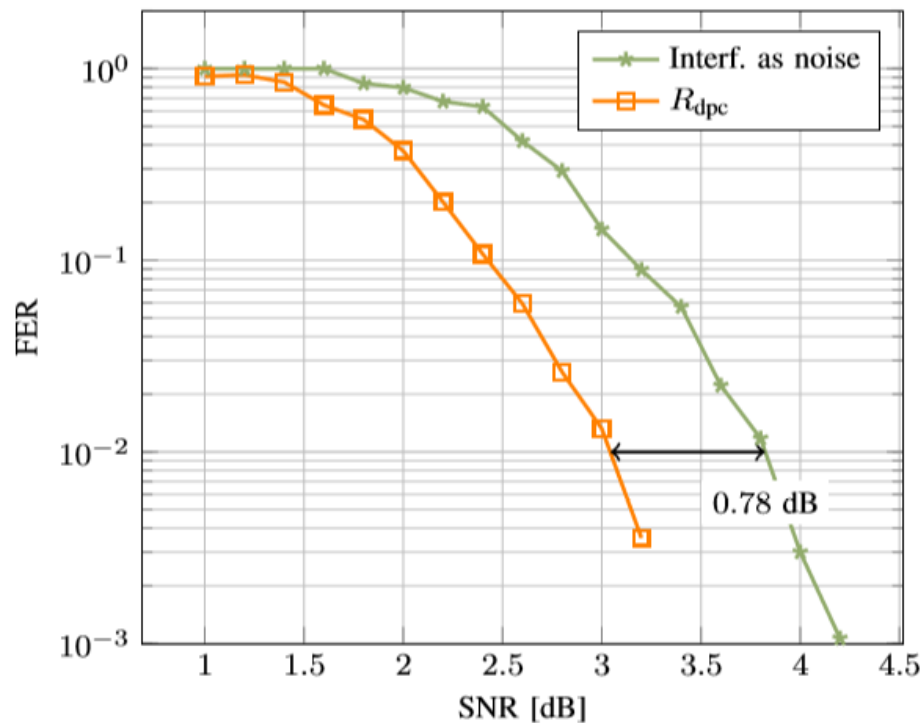
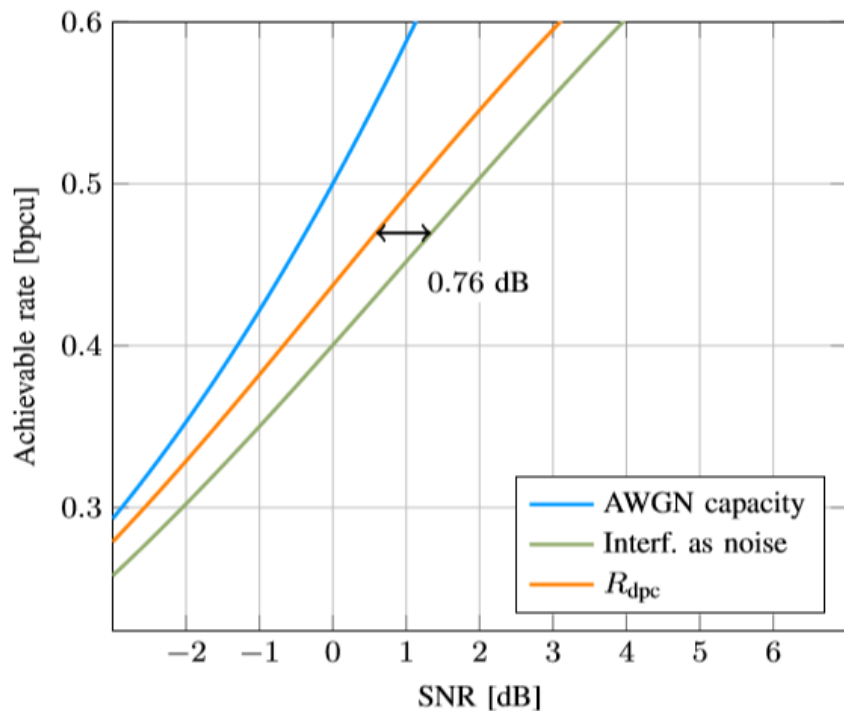

- Rate 0.5, block length  $\approx 1000$   
Wimax LDPC codes
- $\ell = 16$

# Conclusions

- **Summary:**
  - Layered PS architecture for linear codes.
  - Extending PAS by not requiring un-constrained bits.
  - Syndrome distribution matching as enabling component
- **Next steps:**
  - efficient SDM algorithms
  - Applications

# References

1. G. Böcherer, F. Steiner, and P. Schulte, “Bandwidth efficient and rate-matched low-density parity-check coded modulation,” *IEEE Trans. Commun.*, vol. 63, no. 12, pp. 4651–4665, Dec. 2015.
2. W. G. Bliss, “Circuitry for performing error correction calculations on baseband encoded data to eliminate error propagation,” *IBM Tech. Discl. Bull.*, vol. 23, pp. 4633–4634, Mar. 1981.
3. A. Git, B. Matuz, and F. Steiner, “Protograph-Based LDPC Code Design for Probabilistic Shaping with On-Off Keying,” in *Proc. Ann. Conf. Inf. Sci. Syst. (CISS)*, Mar. 2019.
4. G. Böcherer, P. Schulte, and F. Steiner, “Probabilistic Shaping and Forward Error Correction for Fiber-Optic Communication Systems,” *J. Lightw. Technol.*, vol. 37, no. 2, pp. 230–244, Jan. 2019.
5. G. Kramer, “Topics in multi-user information theory,” *Foundations and Trends in Comm. and Inf. Theory*, vol. 4, no. 4–5, pp. 265–444, 2007.
6. D. Lentner, “Dirty paper coding for higher-order modulation and finite constellation interference,” Master’s thesis, Technical University of Munich, 2018.
7. G. Böcherer, D. Lentner, A. Cirino, and F. Steiner, “Probabilistic parity shaping for linear codes,” arXiv preprint, 2019. [Online]. Available: <https://arxiv.org/abs/1902.10648>